

PLANTA
esc 1:20

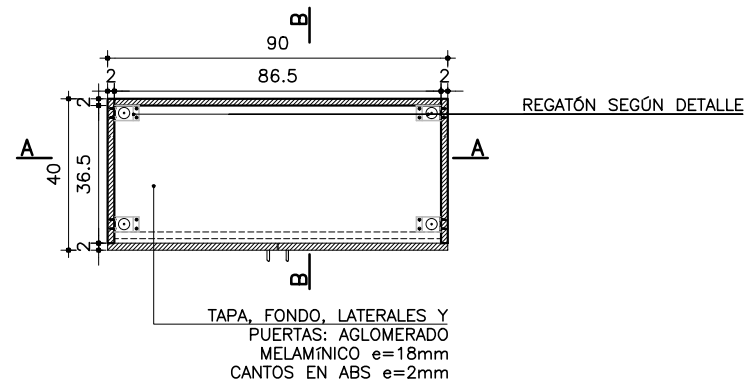

DETALLE REGATÓN
esc 1:2

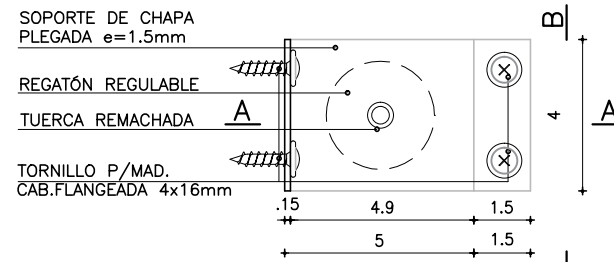

PLANTA

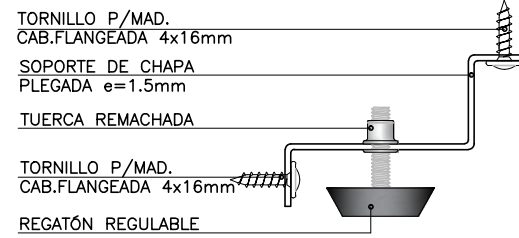

CORTE A-A

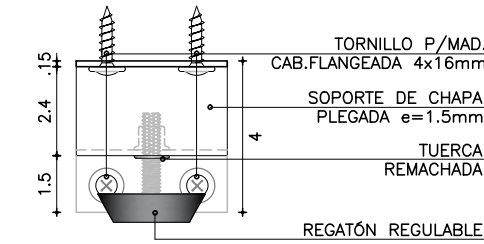

CORTE B-B

DETALLE 1
esc 1:2

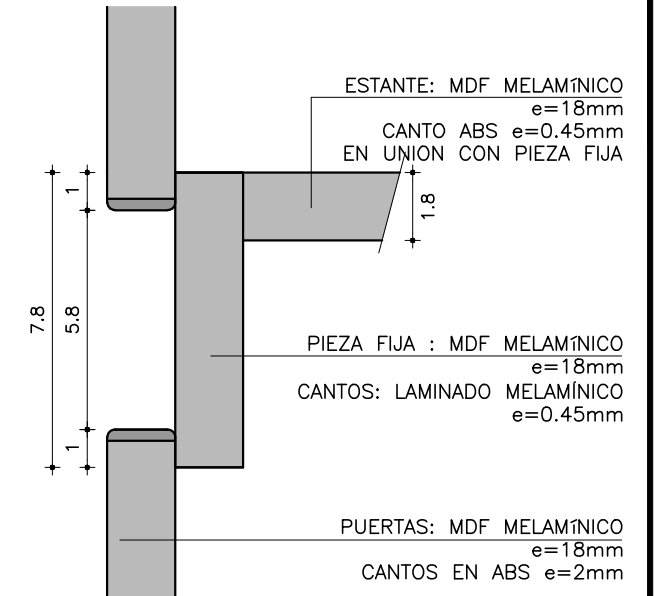

VISTA FRONTAL
esc 1:20

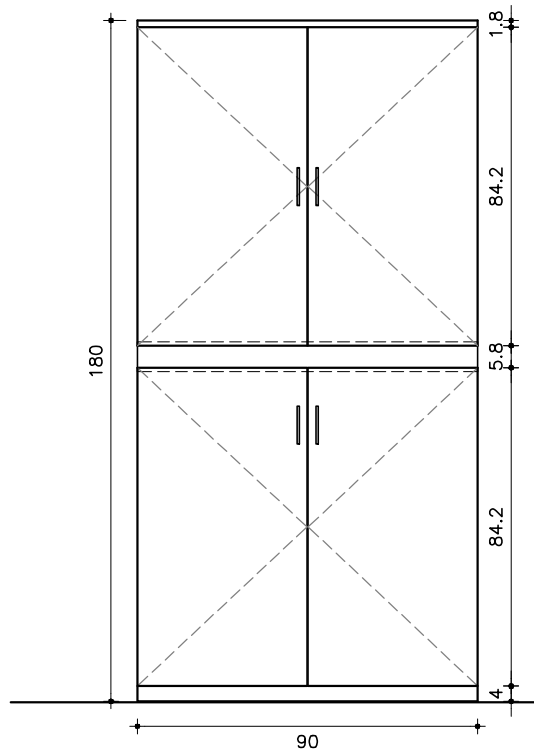

CORTE A-A
esc 1:20

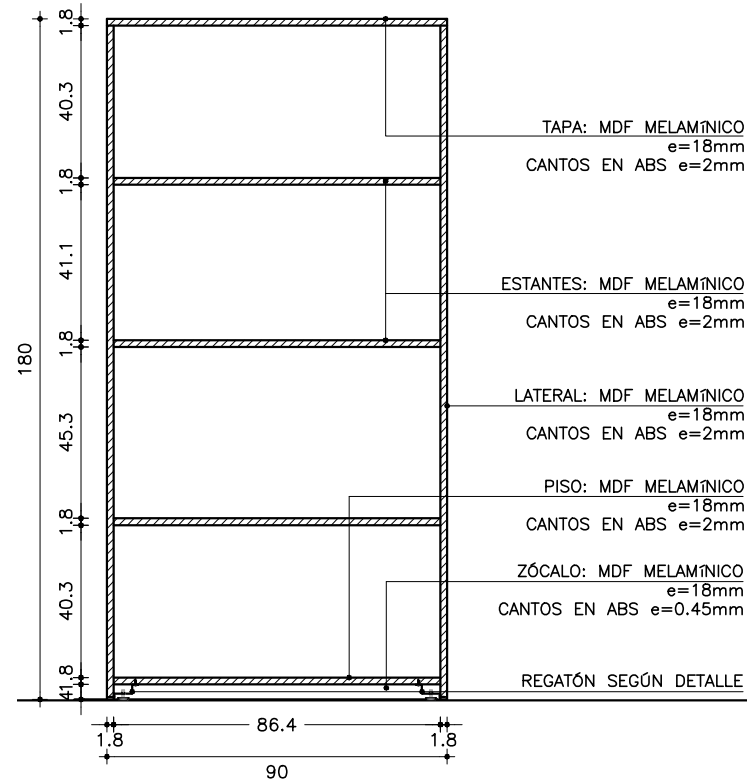

CORTE B-B
esc 1:20

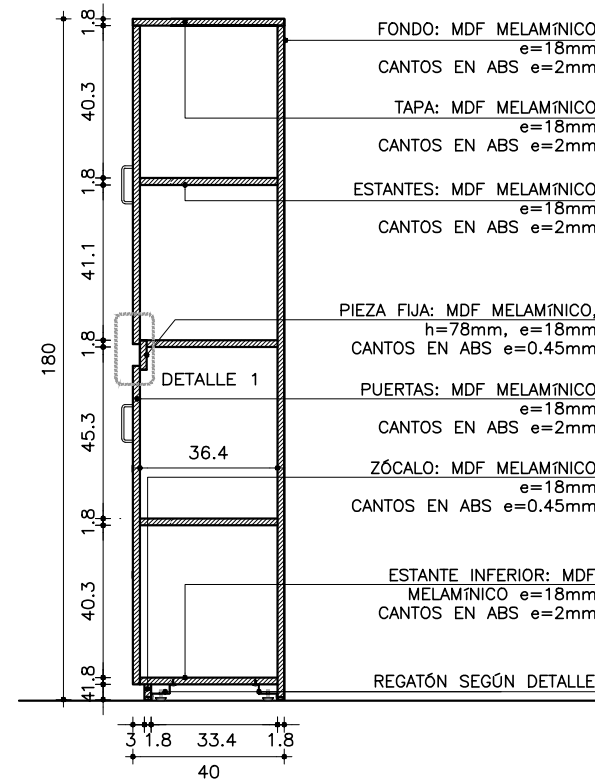

VISTA LATERAL
esc 1:20

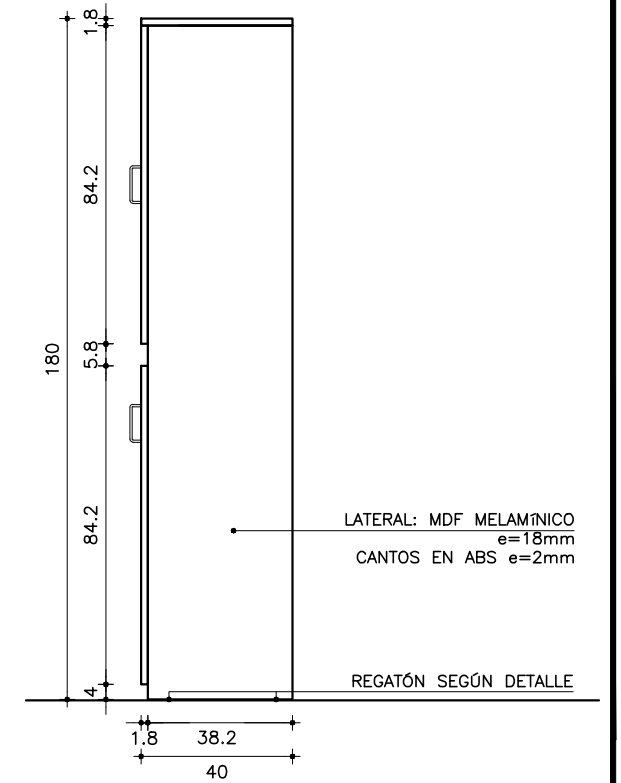

NOTA: TODAS LAS COTAS SON EN CM.

ESTRUCTURA	
MATERIAL:	PLACA MDF MELAMÍNICO
ESPELOR:	18 mm
TERMINACIÓN:	SEGÚN ESPECIFICACIONES GENERALES
OBSERVACIONES:	MELAMÍNICO COLOR GRIS GRAFITO OSCURO

COMPLEMENTOS	
MATERIAL:	PLACA MDF MELAMÍNICO
ESPELOR:	18mm
FIJACIÓN:	TERMINACIÓN
CANTO:	ABS e=2mm
TERMINACIÓN:	MELAMÍNICO COLOR GRIS GRAFITO OSCURO
OTROS:	

EQUIPAMIENTO MOBILIARIO	
ARMARIO ALTO CERRADO	ITEM 4.4
FECHA: FEB. 2018	
PRÉSTAMO BID 3773 / OC - UR	PAEMIFE ÁREA DE INFRAESTRUCTURA TALLER DE DISEÑO
ANEP - CODIGEN	