

CASILLA DE ABONADOS

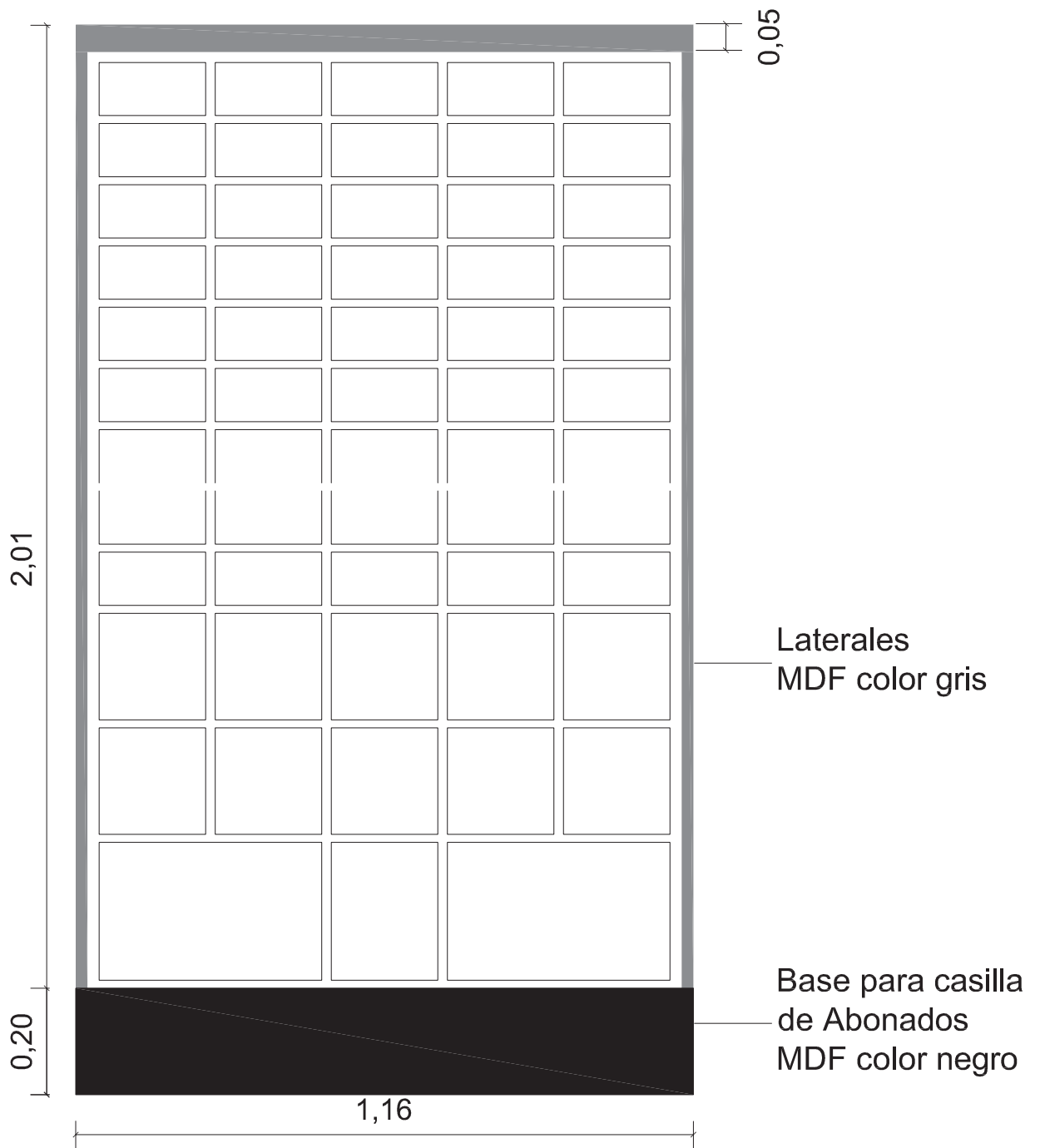

MESA DE CLASIFICACION

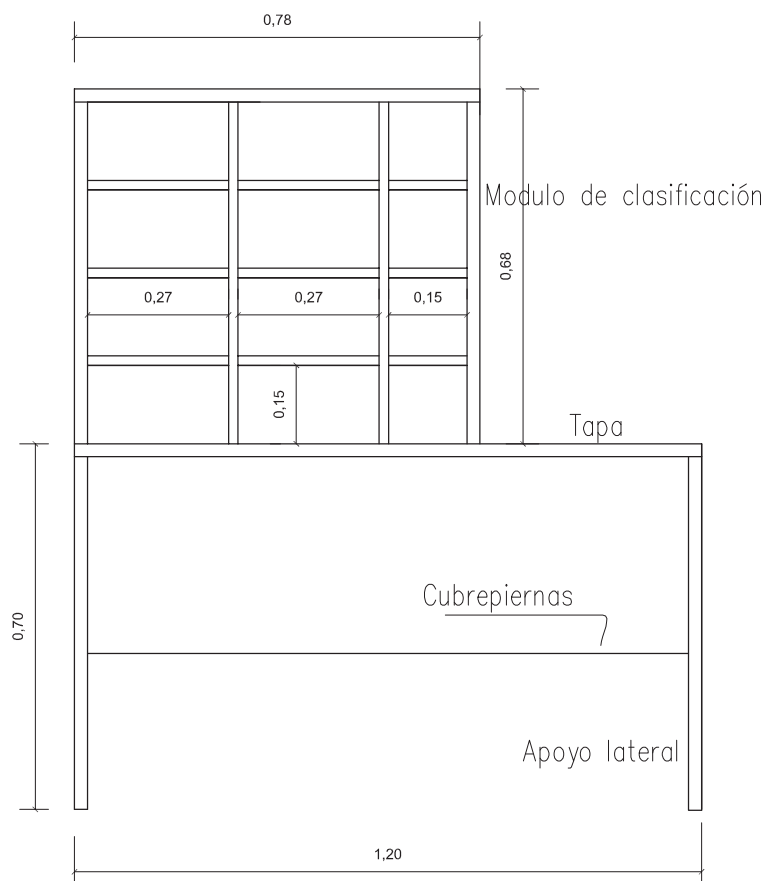
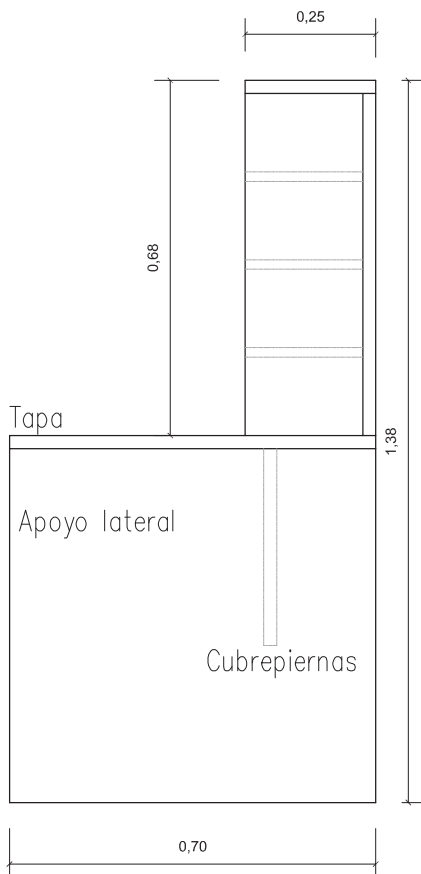
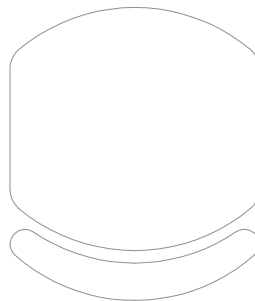
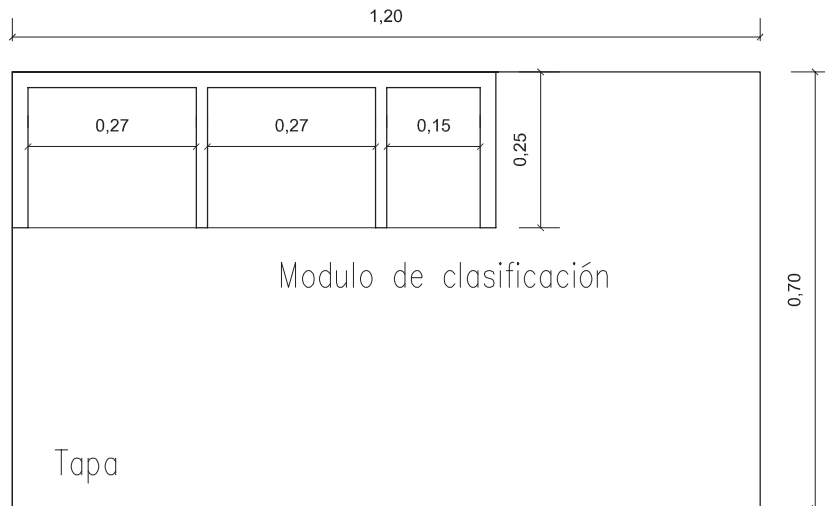

MUEBLE ESQUINERO CURVO

PLANTA

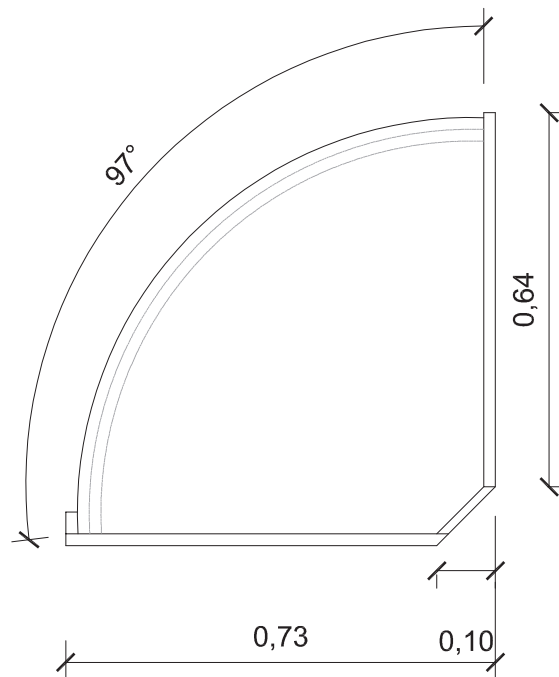

CORTE

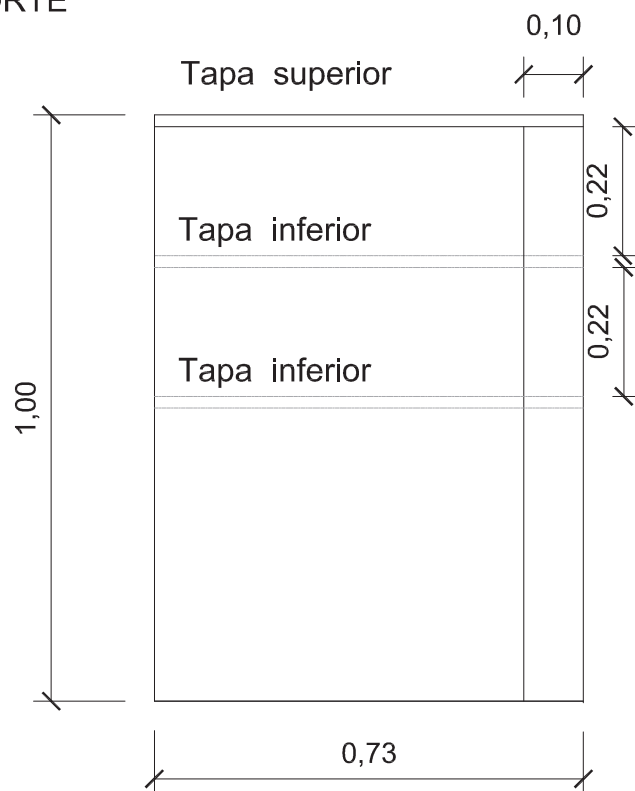

ESQUEMA DE UBICACION DE MUEBLES

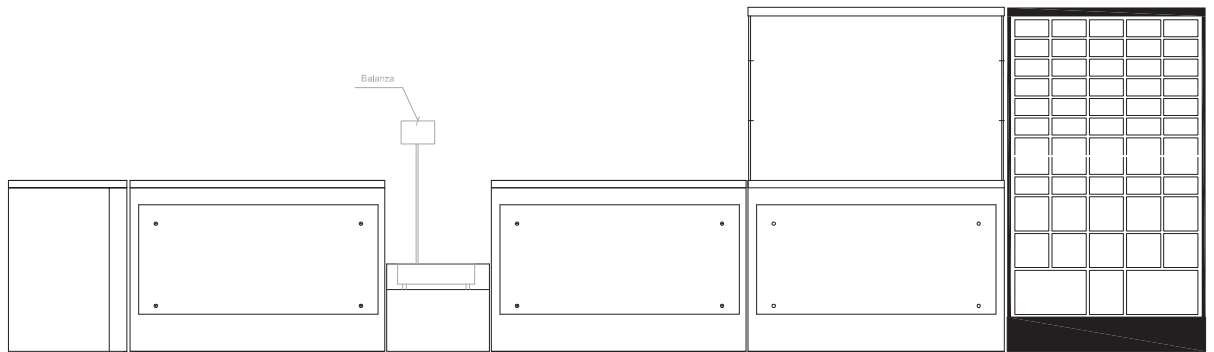
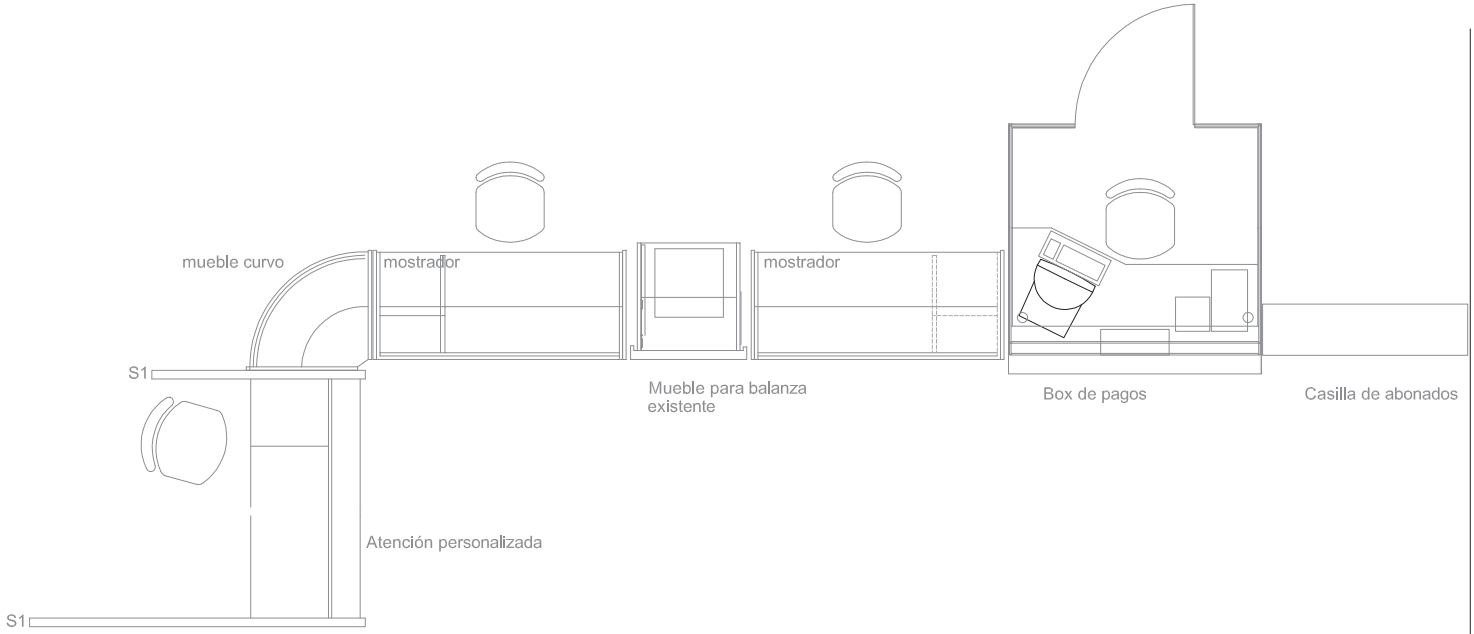

ITEM N° 9: se modifica tapa de color negro por tapa gris humo, Se trata de una base en melamínico para el apoyo de una casilla, la casilla no tiene regatones, apoya toda la base sobre la tarima.