

CALLE	CALLE YI																			
DIST. PARCIALES	0.00	0.00	12.00	0.00	10.00	10.00	10.00	10.00	10.00	10.00	10.00	10.00	10.00	10.00	10.00	10.00	10.00	10.00	10.00	10.00
DIST. ACUMULADAS	0.00	0.00	12.00	12.00	22.00	32.00	42.00	52.00	62.00	72.00	82.00	92.00	102.00	112.00	122.00	132.00	142.00	152.00	162.00	172.00
COTA DE PAVIMENTO	26.00	26.00	26.00	26.00	26.00	26.00	26.00	26.00	26.00	26.00	26.00	26.00	26.00	26.00	26.00	26.00	26.00	26.00	26.00	26.00
COTA FONDO DE ZANJA	25.00	25.00	25.00	25.00	25.00	25.00	25.00	25.00	25.00	25.00	25.00	25.00	25.00	25.00	25.00	25.00	25.00	25.00	25.00	25.00

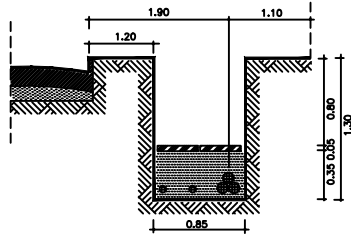

ADMINISTRACION NACIONAL DE USINAS Y TRANSMISIONES ELECTRICAS
 LICITACION F39 bis.
TRANSELEKTRO - MKV MAGYAR KABEL MVEK HUNGARIAN CABLE WORKS
 COMPANIA SUDAMERICANA DE EMPRESAS ELECTRICAS, MECANICAS Y DE OBRAS PUBLICAS, SOCIEDAD ANONIMA.
 TENDIDO: CABLE 150 KV - CABLE PILDITO - FIBRA OPTICA
 TRAMO 2 RECORRIDO DE YI Y COLONIA
 TENDIDO 15 A YI 1542
 PROYECTADO: [] DISEÑADO: [] REVISADO: [] APROBADO: [] FECHA: 15/03/04 ESCALA: 1:1000 1:100 1:50 1:25

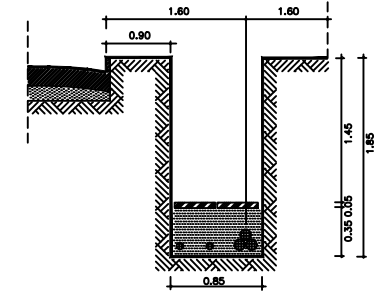
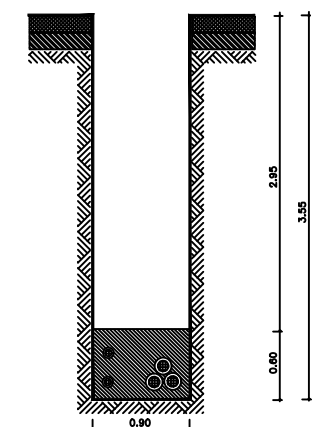
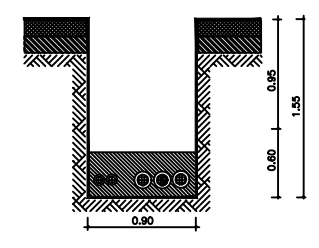
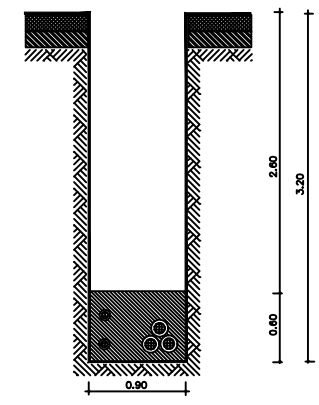
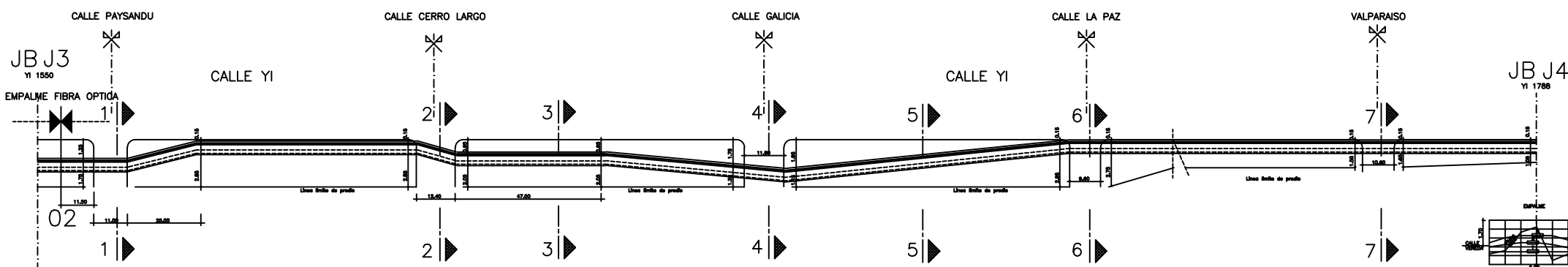

PLANIMETRIA

Escala - 1:500, 1:100

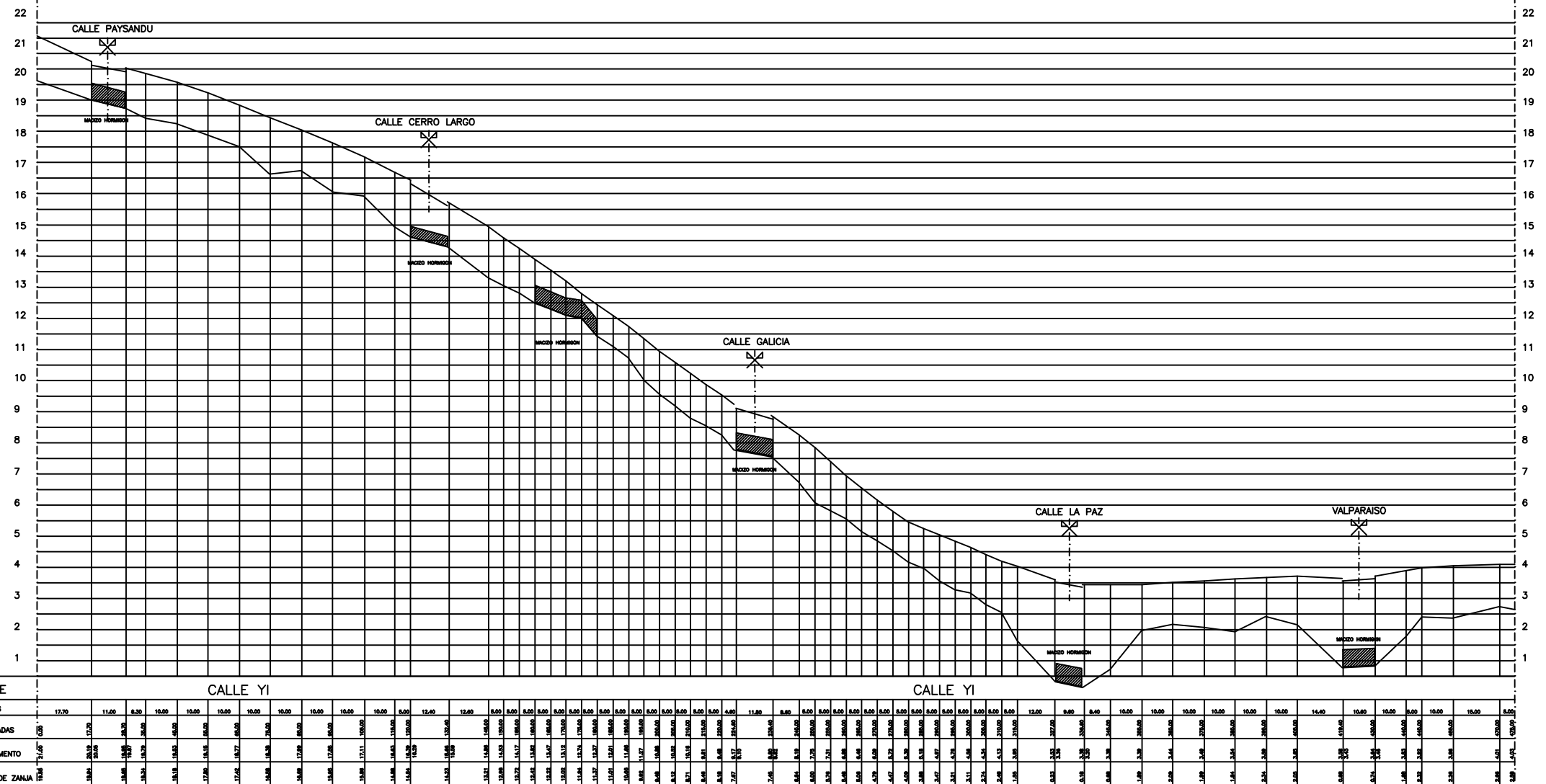

ALTIMETRIA

Escala - 1:500, 1:50

JBJ3

JBJ4

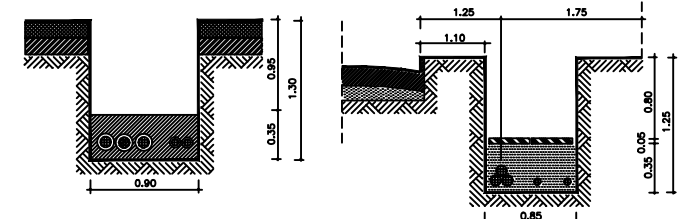

CORTE 1-1

CORTE 5-5

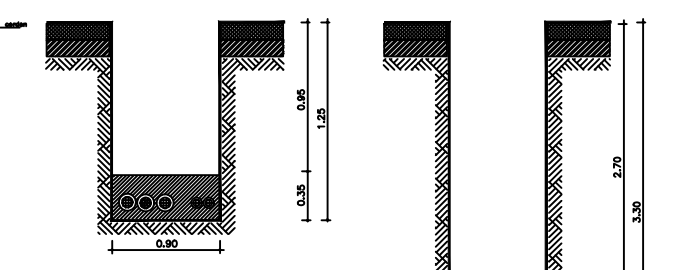

CORTE 2-2

CORTE 6-6

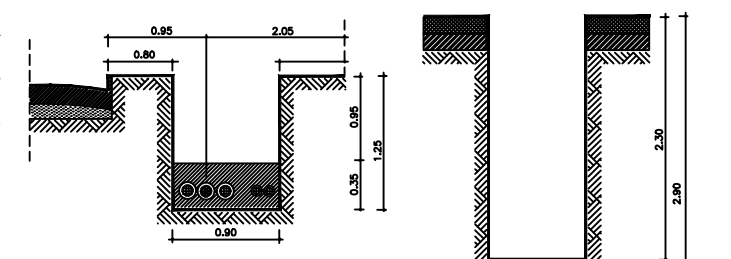

CORTE 3-3

CORTE 7-7

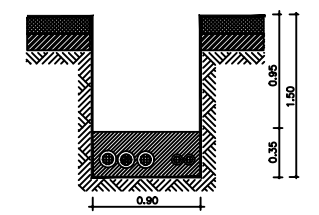

CORTE 4-4

EMPALME FIBRA OPTICA

UTE DE ADMINISTRACION NACIONAL DE USINAS Y TRANSMISIONES ELECTRICAS
 LICITACION F39 bis.

TRANSELEKTRO - MKM MAGYAR KABEL MVEK HUNGARIAN CABLE WORKS

COMPANIA SUDAMERICANA DE EMPRESAS ELECTRICAS, MECANICAS Y DE OBRAS PUBLICAS, SOCIEDAD ANONIMA.

TENDIDO: CABLE 150 KV = CABLE PILDOT = FIBRA OPTICA

TRAMO 2 RECORRIDO DE YI 1550
 TENDIDO 16 A YI 1788

PROYECTADO: ESTUDIOS: REVISADO: APROBADO: FECHA: ESCALAS:
 G.P. 06/05/94 1:500 1:100
 1:50 1:50

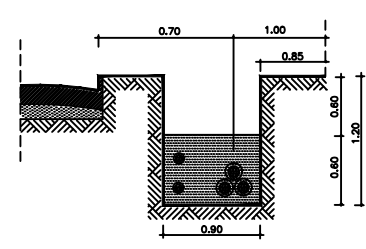

CORTE 1-1

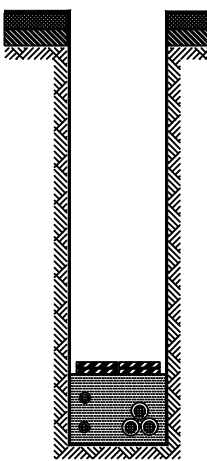

CORTE 2-2

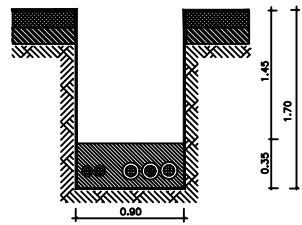

CORTE 3-3

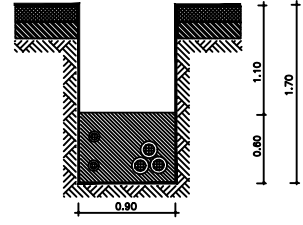

CORTE 4-4

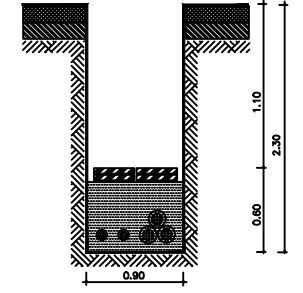

CORTE 5-5

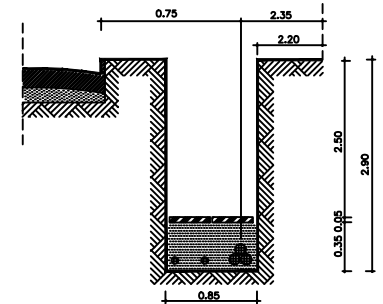

CORTE 6-6

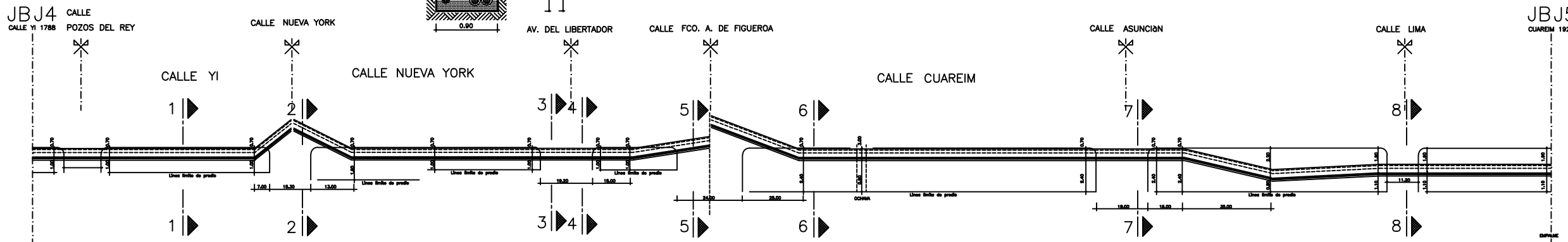

PLANIMETRIA
Escala - 1:500, 1:100

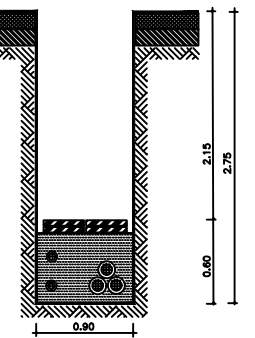
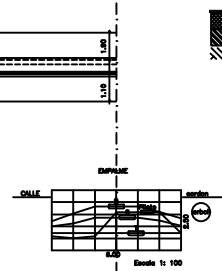

CORTE 7-7

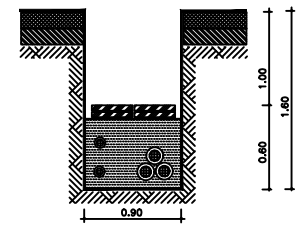

CORTE 8-8

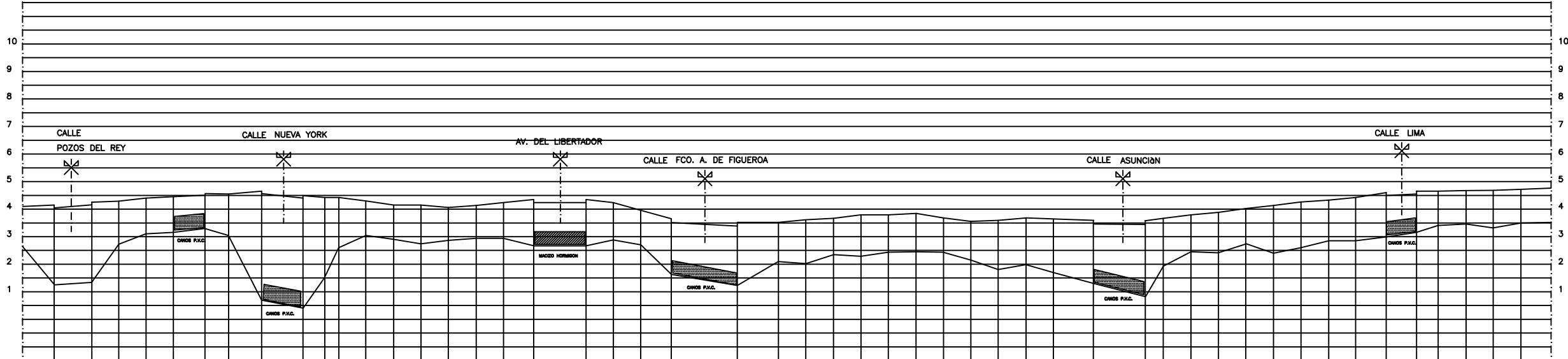

ALTIMETRIA
Escala - 1:500, 1:50

CALLE	CALLE YI										CALLE NUEVA YORK										CALLE CUAREIM															
DIST. PARCIALES	11.80	13.80	8.70	10.00	10.00	11.40	8.80	10.00	10.00	10.00	7.70	8.00	10.00	10.00	10.00	10.00	10.00	10.00	10.00	10.00	10.00	10.00	10.00	10.00	10.00	10.00	10.00	10.00	10.00	10.00	10.00	10.00	10.00	10.00	10.00	10.00
DIST. ACUMULADAS	0.00	11.80	25.60	34.30	44.30	55.70	64.50	74.50	84.50	94.50	102.20	110.20	118.20	126.20	134.20	142.20	150.20	158.20	166.20	174.20	182.20	190.20	198.20	206.20	214.20	222.20	230.20	238.20	246.20	254.20	262.20	270.20	278.20	286.20	294.20	302.20
COTA DE PAVIMENTO	0.50	0.50	0.50	0.50	0.50	0.50	0.50	0.50	0.50	0.50	0.50	0.50	0.50	0.50	0.50	0.50	0.50	0.50	0.50	0.50	0.50	0.50	0.50	0.50	0.50	0.50	0.50	0.50	0.50	0.50	0.50	0.50	0.50	0.50	0.50	
COTA FONDO DE ZANJA	1.00	1.00	1.00	1.00	1.00	1.00	1.00	1.00	1.00	1.00	1.00	1.00	1.00	1.00	1.00	1.00	1.00	1.00	1.00	1.00	1.00	1.00	1.00	1.00	1.00	1.00	1.00	1.00	1.00	1.00	1.00	1.00	1.00	1.00	1.00	

UTE ADMINISTRACION NACIONAL DE USINAS Y TRANSMISIONES ELECTRICAS

LICITACION F39 bis.

TRANSELEKTRO - MKM MAGYAR KABEL MVEK HUNGARIAN CABLE WORKS

COMPANIA SUDAMERICANA DE EMPRESAS ELECTRICAS, MECANICAS Y DE OBRAS PUBLICAS, SOCIEDAD ANONIMA.

TENDIDO: CABLE 150 KV - CABLE PILOTO - FIBRA OPTICA

TRAMO 2 RECORRIDO DE CALLE YI 1788

TENDIDO 17 A CUAREIM 1920

PROYECTADO: ESTABANO REVISADO: APENDIZ FECHA: ESCALA: 02/06/94 1:500 1:100

JB4

JB5

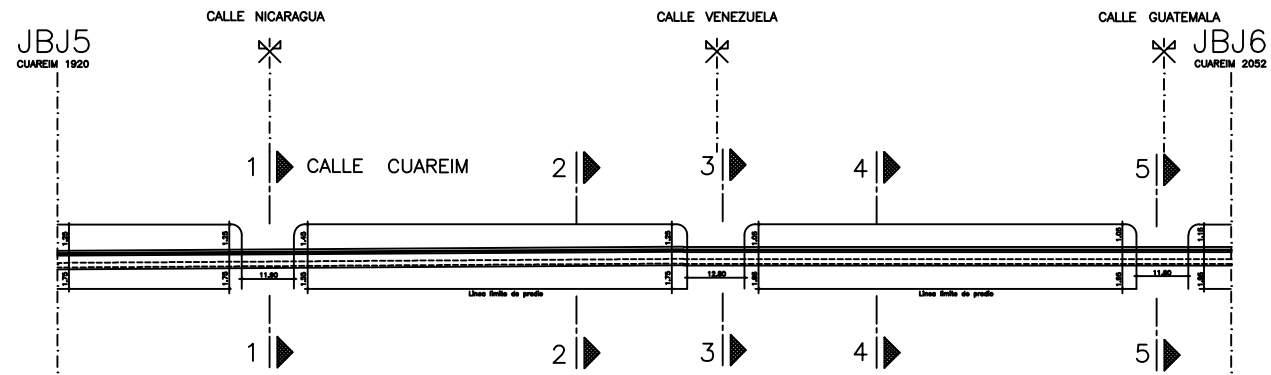

PLANIMETRIA
Escala = 1:500, 1:100

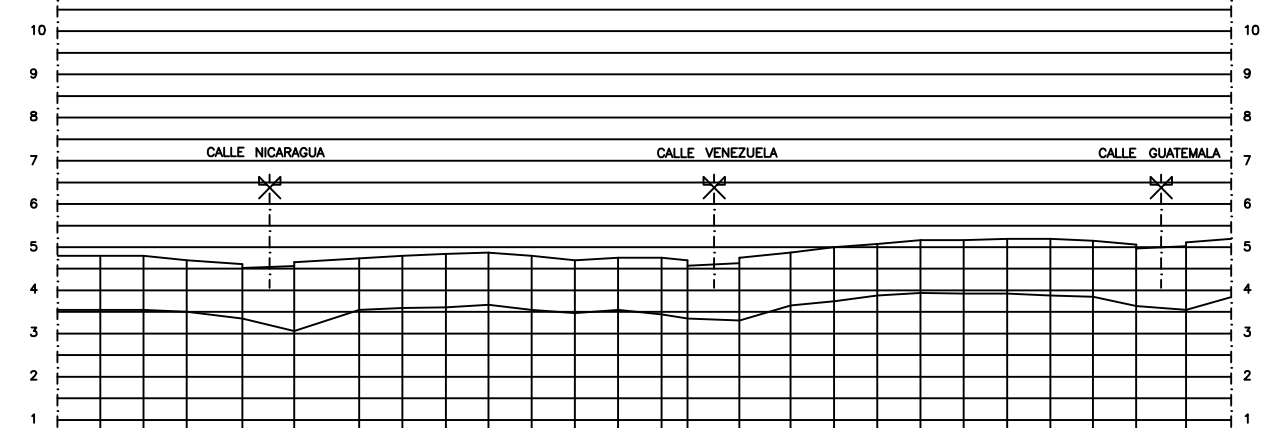
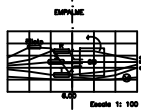

CALLE	CALLE CUAREIM																				
DIST. PARCIALES	10.00	10.00	10.00	10.00	11.00	10.10	10.00	10.00	10.00	10.00	10.00	10.00	10.00	10.00	10.00	10.00	10.00	10.00	10.00	11.00	10.00
DIST. ACUMULADAS	0.00	10.00	20.00	30.00	41.00	51.10	61.10	71.10	81.10	91.10	101.10	111.10	121.10	131.10	141.10	151.10	161.10	171.10	181.10	191.10	201.10
COTA DE PAVIMENTO	2.70	2.70	2.68	2.68	2.65	2.65	2.65	2.65	2.65	2.65	2.65	2.65	2.65	2.65	2.65	2.65	2.65	2.65	2.65	2.65	2.65
COTA FONDO DE ZANJA	1.80	1.80	1.80	1.80	1.80	1.80	1.80	1.80	1.80	1.80	1.80	1.80	1.80	1.80	1.80	1.80	1.80	1.80	1.80	1.80	1.80

ALTIMETRIA
Escala = 1:500, 1:50

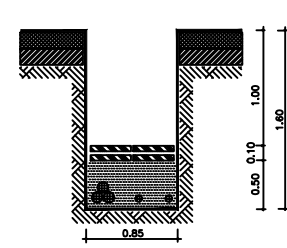

COORTE 1-1

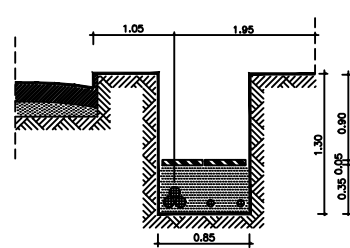

COORTE 4-4

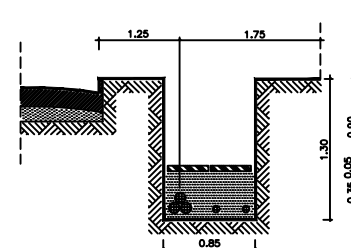

COORTE 2-2

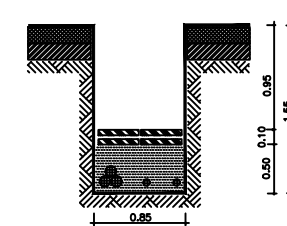

COORTE 5-5

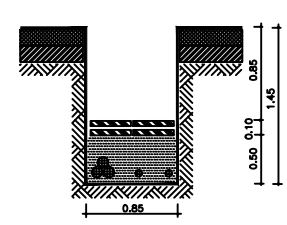

COORTE 3-3

UTE ADMINISTRACION NACIONAL DE USINAS Y TRANSMISIONES ELECTRICAS
LICITACION F39 bis.

TRANSELEKTRO - MKV MAGYAR KABEL MŰVEK HUNGARIAN CABLE WORKS

COMPANIA SUDAMERICANA DE EMPRESAS ELECTRICAS, MECANICAS Y DE OBRAS PUBLICAS, SOCIEDAD ANONIMA.

TENDIDO: CABLE 150 KV - CABLE PILDITO - FIBRA OPTICA

TRAMO 2 RECORRIDO DE CUAREIM 1920 A CUAREIM 2052

PROYECTADO: [] DISEÑADO: [] REVISADO: [] APROBADO: [] FECHA: 08/05/94 ESCALA: 1:500 1:100 1:50 1:25

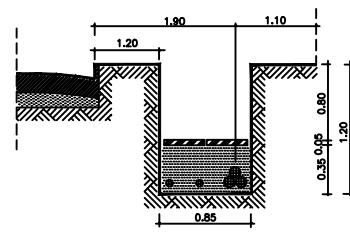

CORTE 1-1

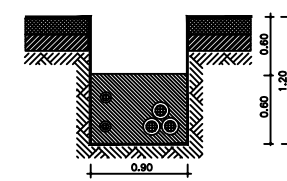

CORTE 2-2

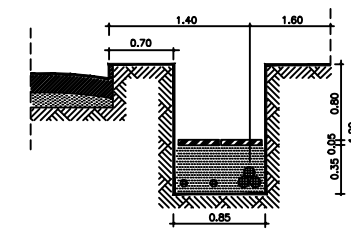

CORTE 3-3

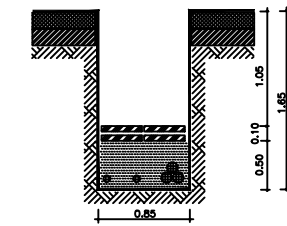

CORTE 4-4

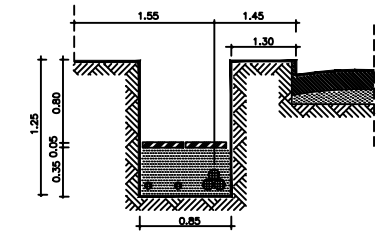

CORTE 5-5

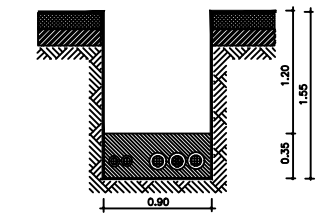

CORTE 6-6

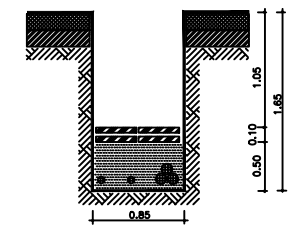

CORTE 7-7

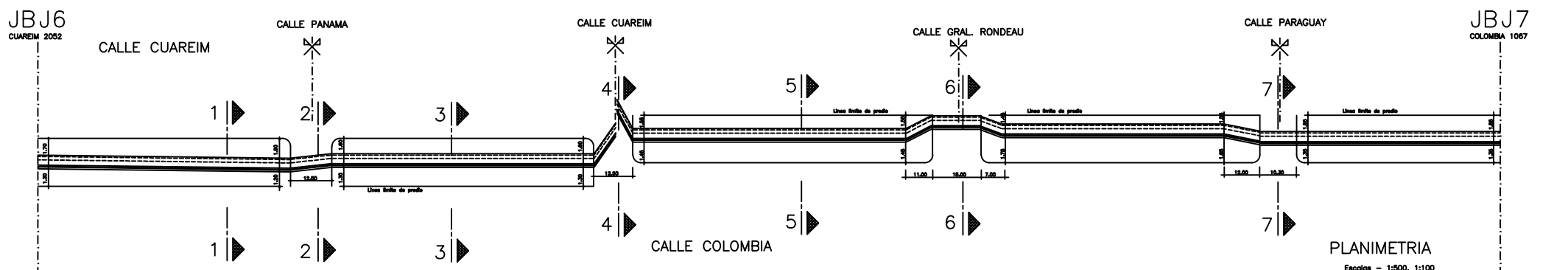

PLANIMETRIA
Escala - 1:500, 1:100

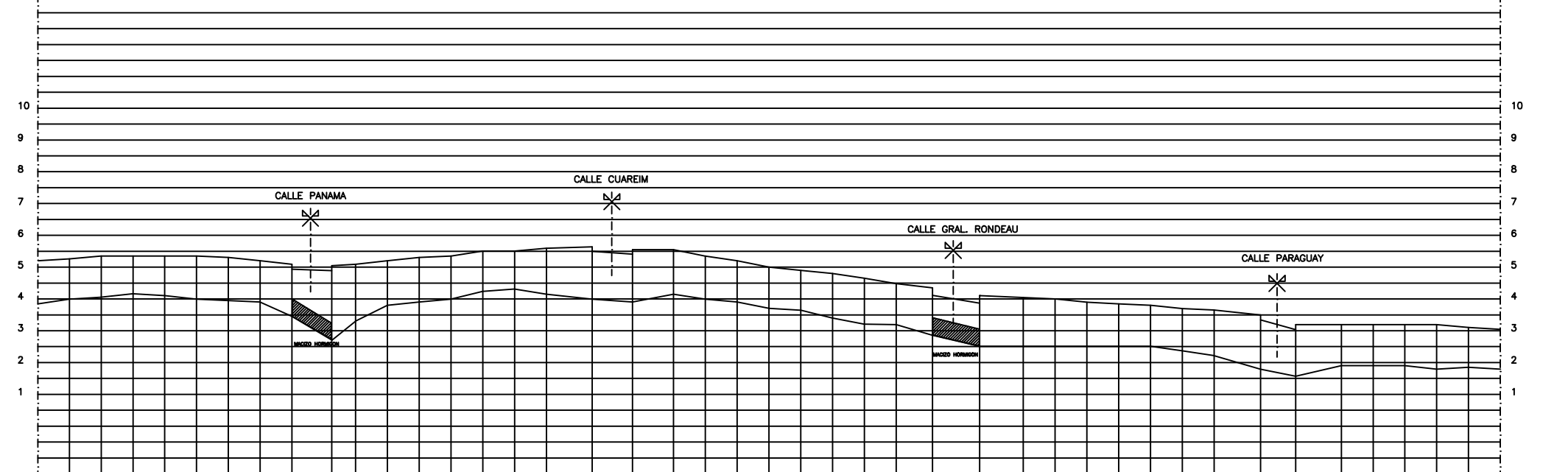

ALTIMETRIA
Escala - 1:500, 1:50

CALLE	CALLE CUAREIM										CALLE COLOMBIA										CALLE PARAGUAY												
DIST. PARCIALES	10.00	10.00	10.00	10.00	10.00	10.00	10.00	10.00	10.00	10.00	10.00	10.00	10.00	10.00	10.00	10.00	10.00	10.00	10.00	10.00	10.00	10.00	10.00	10.00	10.00	10.00	10.00	10.00	10.00	10.00	10.00	10.00	10.00
DIST. ACUMULADAS	0.00	10.00	20.00	30.00	40.00	50.00	60.00	70.00	80.00	90.00	100.00	110.00	120.00	130.00	140.00	150.00	160.00	170.00	180.00	190.00	200.00	210.00	220.00	230.00	240.00	250.00	260.00	270.00	280.00	290.00	300.00	310.00	320.00
COTA DE PAVIMENTO	0.11	0.11	0.11	0.11	0.11	0.11	0.11	0.11	0.11	0.11	0.11	0.11	0.11	0.11	0.11	0.11	0.11	0.11	0.11	0.11	0.11	0.11	0.11	0.11	0.11	0.11	0.11	0.11	0.11	0.11	0.11	0.11	0.11
COTA FONDO DE ZANJA	0.00	0.00	0.00	0.00	0.00	0.00	0.00	0.00	0.00	0.00	0.00	0.00	0.00	0.00	0.00	0.00	0.00	0.00	0.00	0.00	0.00	0.00	0.00	0.00	0.00	0.00	0.00	0.00	0.00	0.00	0.00	0.00	0.00

ADMINISTRACIÓN NACIONAL DE USINAS Y TRANSMISIONES ELÉCTRICAS
 LICITACION F39 bis.
TRANSELEKTRO - MKV MAGYAR KABEL MVE RTK
 HUNGARIAN CABLE WORKS LTD.
 COMPANIA SUDAMERICANA DE EMPRESAS ELÉCTRICAS, MECÁNICAS Y DE OBRAS PÚBLICAS, SOCIEDAD ANÓNIMA.
 TENDIDO: CABLE 150 KV - CABLE PILDTO - FIBRA OPTICA
 TRAMO 2 RECORRIDO DE CUAREIM 2052 A COLOMBIA 1067
 TENDIDO 19
 PROYECTADO: [] DISEÑADO: [] REVISADO: [] APROBADO: [] FECHA: 24/08/94 ESCALAS: 1:500 1:100 1:50

JB J7
COLOMBIA 1067

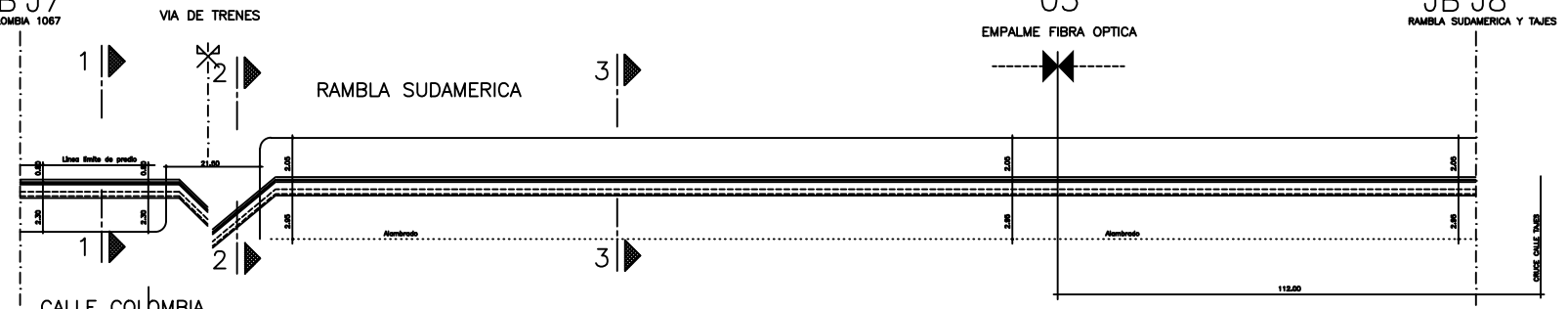

PLANIMETRIA
Escala - 1:500, 1:100

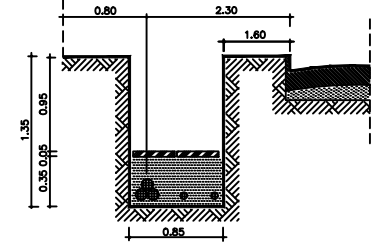
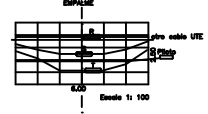

CORTE 1-1

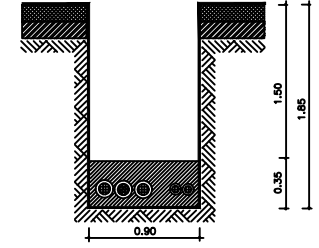

CORTE 2-2

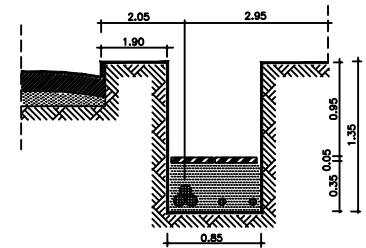

CORTE 3-3

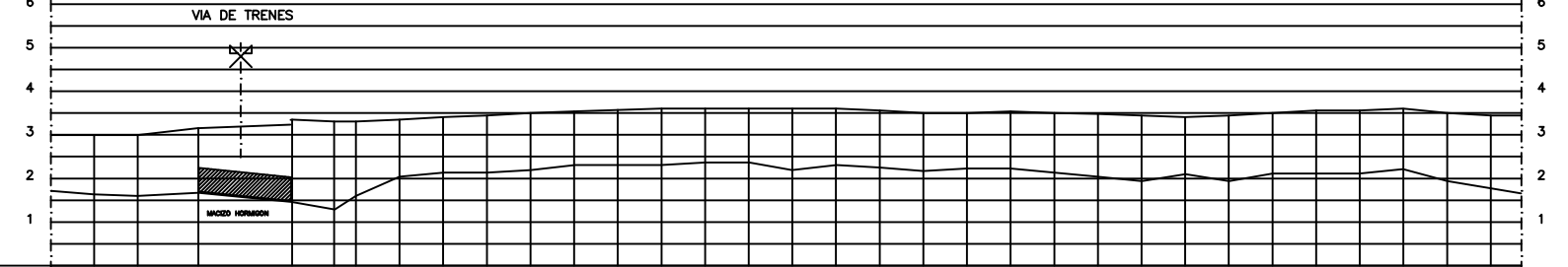

ALTIMETRIA
Escala - 1:500, 1:50

CALLE	CALLE COLOMBIA		RAMBLA SUDAMERICA																													
DIST. PARCIALES	10.00	10.00	14.00	21.00	8.00	8.00	10.00	10.00	10.00	10.00	10.00	10.00	10.00	10.00	10.00	10.00	10.00	10.00	10.00	10.00	10.00	10.00	10.00	10.00	10.00	10.00	10.00	10.00	10.00	10.00	10.00	8.00
DIST. ACUMULADAS	10.00	20.00	34.00	55.00	63.00	71.00	81.00	91.00	101.00	111.00	121.00	131.00	141.00	151.00	161.00	171.00	181.00	191.00	201.00	211.00	221.00	231.00	241.00	251.00	261.00	271.00	281.00	291.00	301.00	311.00	319.00	
COTA DE PAVIMENTO	2.00	2.00	2.00	2.00	2.00	2.00	2.00	2.00	2.00	2.00	2.00	2.00	2.00	2.00	2.00	2.00	2.00	2.00	2.00	2.00	2.00	2.00	2.00	2.00	2.00	2.00	2.00	2.00	2.00	2.00	2.00	
COTA FONDO DE ZANJA	1.40	1.40	1.40	1.40	1.40	1.40	1.40	1.40	1.40	1.40	1.40	1.40	1.40	1.40	1.40	1.40	1.40	1.40	1.40	1.40	1.40	1.40	1.40	1.40	1.40	1.40	1.40	1.40	1.40	1.40	1.40	

JB J7

JB J8

		ADMINISTRACION NACIONAL DE USINAS Y TRANSMISIONES ELECTRICAS	
LICITACION F39 bis.			
		COMPANIA HUNGARIANA CABLE TELEVISION	
COMPANIA SUDAMERICANA DE EMPRESAS ELECTRICAS, MECANICAS Y DE OBRAS PUBLICAS, SOCIEDAD ANONIMA.			
TENDIDO CABLE 150 KV = CABLE PILOTO = FIBRA OPTICA		TRAMO 2 RECORRIDO DE COLOMBIA 1067 TENDIDO 20 A RAMBLA SUDAMERICA Y TAJES	
PROYECTADO O.P.	DISEÑADO O.P.	REVISADO O.P.	APROBADO O.P.
FECHA 05/07/94		ESCALAS 1:500 1:100 1:50	

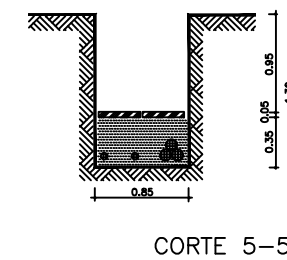
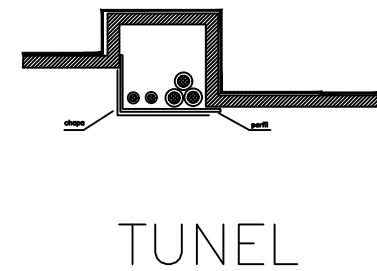
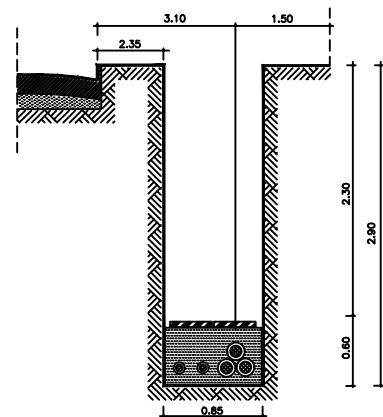
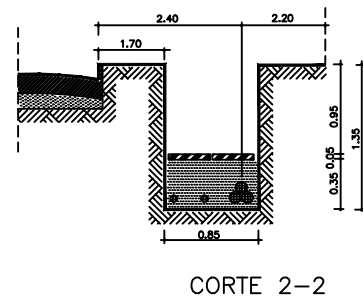
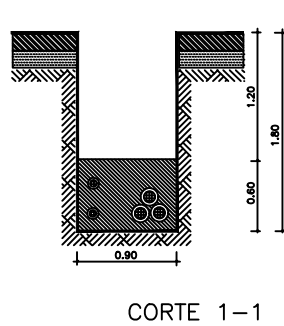

JBJ8
JUJUY Y CNEL. FCO. TAJES

CENTRAL BATLLE

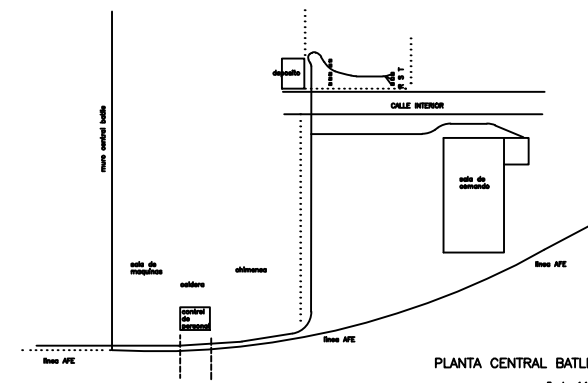
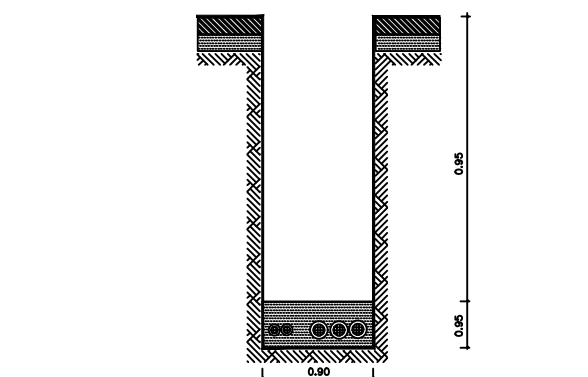
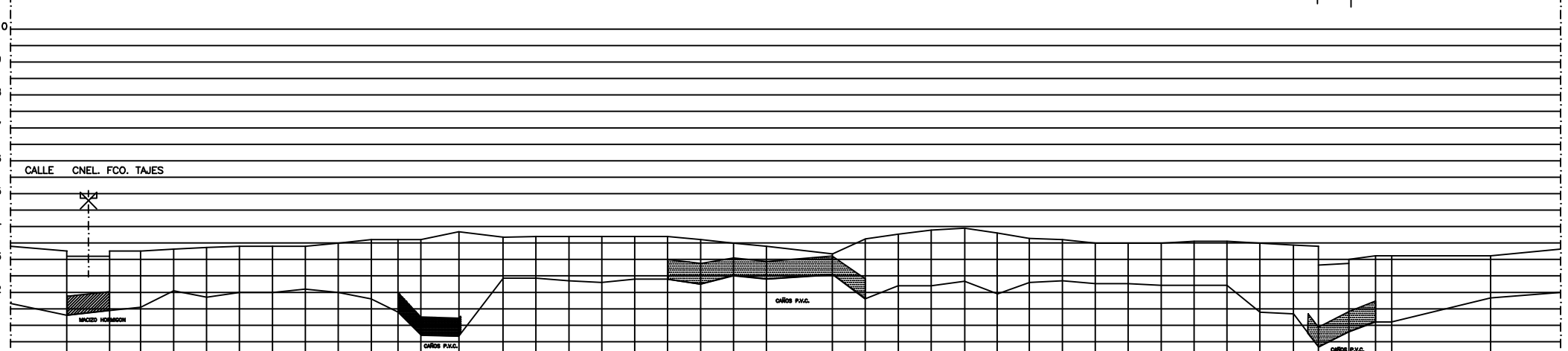
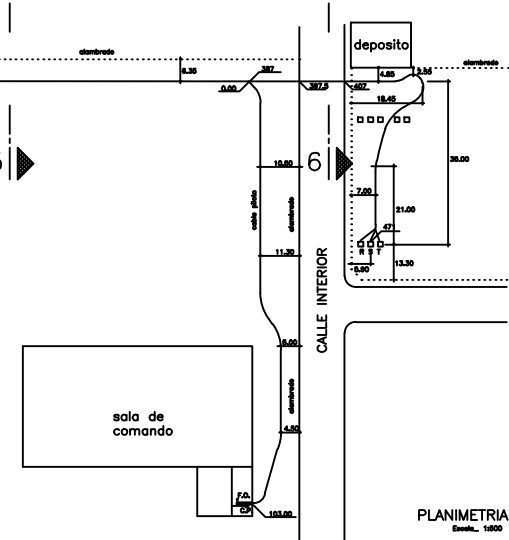
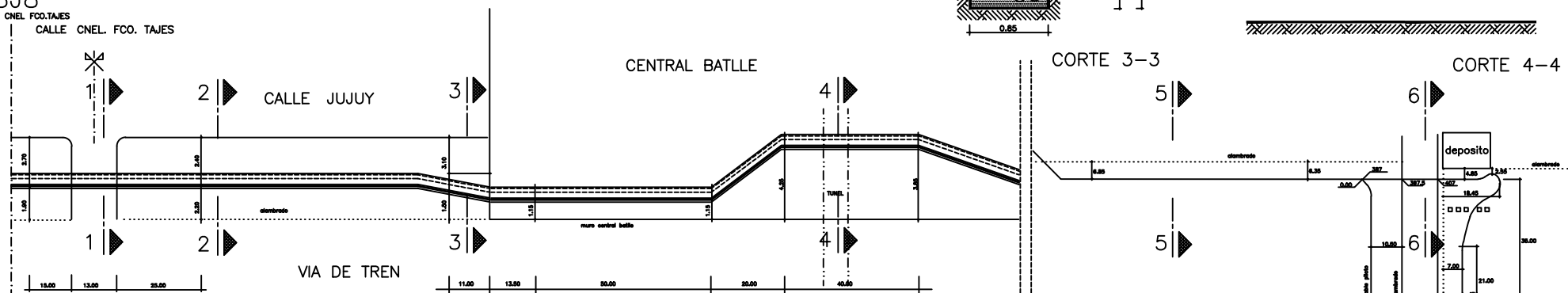

CALLE	CALLE JUJUY										CENTRAL BATLLE																														
DIST. PARCIALES	17,00	13,00	8,00	10,00	10,00	10,00	10,00	10,00	10,00	10,00	8,00	7,00	11,00	13,00	10,00	10,00	10,00	10,00	10,00	10,00	10,00	20,00	10,00	10,00	10,00	10,00	10,00	10,00	10,00	10,00	10,00	10,00	10,00	10,00	7,00	8,00	8,00	8,00	30,00	21,00	
DIST. ACUMULADAS	17,00	30,00	38,00	48,00	58,00	68,00	78,00	88,00	98,00	108,00	116,00	123,00	134,00	147,00	157,00	167,00	177,00	187,00	197,00	207,00	217,00	237,00	247,00	257,00	267,00	277,00	287,00	297,00	307,00	317,00	327,00	337,00	347,00	357,00	367,00	377,00	387,00	407,00	428,00		
COTA DE PAVIMENTO	3,54	3,52	3,53	3,52	3,53	3,52	3,52	3,52	3,52	3,52	3,52	3,52	3,52	3,52	3,52	3,52	3,52	3,52	3,52	3,52	3,52	3,52	3,52	3,52	3,52	3,52	3,52	3,52	3,52	3,52	3,52	3,52	3,52	3,52	3,52	3,52	3,52	3,52	3,52	3,52	
COTA FONDO DE ZANJA	3,48	3,48	3,48	3,48	3,48	3,48	3,48	3,48	3,48	3,48	3,48	3,48	3,48	3,48	3,48	3,48	3,48	3,48	3,48	3,48	3,48	3,48	3,48	3,48	3,48	3,48	3,48	3,48	3,48	3,48	3,48	3,48	3,48	3,48	3,48	3,48	3,48	3,48	3,48	3,48	3,48

JBJ20

CENTRAL BATLLE

ADMINISTRACION NACIONAL DE USINAS Y TRANSMISIONES ELECTRICAS
 LICITACION F39 bis.
TRANSELEKTRO - MKMMAGYAR KABEL
 COMPANIA SUDAMERICANA DE EMPRESAS ELECTRICAS, MECANICAS Y DE OBRAS PUBLICAS, SOCIEDAD ANONIMA.
 TENDIDO: CABLE 150 KV = CABLE PILOTO = FIBRA OPTICA
 TRAMO 2 RECORRIDO DE JUJUY Y CNEL. FCO. TAJES
 TENDIDO 21 A CENTRAL BATLLE
 PROYECTADO: [] REVISADO: [] APROBADO: [] FECHA: 10/08/94
 ESCALAS: 1:500 1:200 1:100 1:50